

# 1. Introduction

The common features of the EX-9015H/15H-M modules are as follows:

1. 3000V DC inter-module isolation
2. 24-bit sigma-delta ADC to provide excellent accuracy
3. Direct RTD (resistance temperature detector) connection
4. Off-set value setting by Utility of EX-9000 for individual channel
5. Support 2/3 wire
6. Break line detection
7. Modbus function (EX9015HM only)

EX-9015H/15H-M is a 6-channel RTD input module.  
with individual channel configuration.

Supported RTD types are as follows:

1. Platinum, 100 Ohms at 0°C,  $\alpha = 0.00385$
2. Platinum, 100 Ohms at 0°C,  $\alpha = 0.003916$
3. Platinum, 1000 Ohms at 0°C,  $\alpha = 0.00385$
4. Nickel, 120 Ohms at 0°C,  $\alpha = 0.00672$
5. Copper, 100 Ohms at 0°C,  $\alpha = 0.00421$
6. Copper, 1000 Ohms at 0°C,  $\alpha = 0.00421$
7. Copper, 100 Ohms at 25°C,  $\alpha = 0.00427$
8. Copper, 50 Ohms at 0°C
9. Nickel, 100 Ohms at 0°C

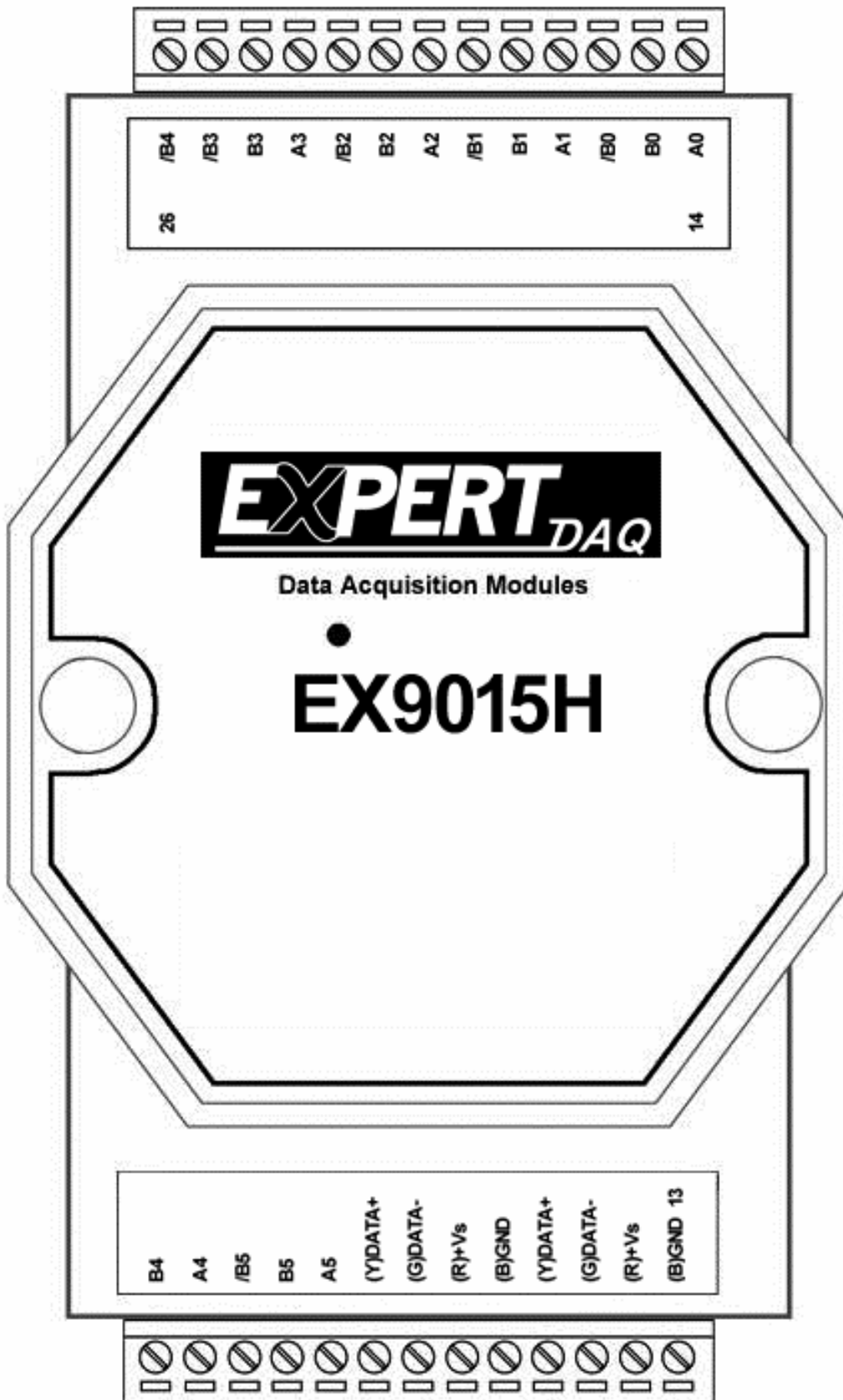

# 1.1 Specifications

	<b>EX-9015H/9015H-M</b>
<b>Analog Input</b>	
Input Channels	<b>6</b>
Input Type	2/3-wire RTD
RTD Type	Pt100 = 0.00385 Pt100 = 0.003916 Ni120 Pt1000 = 0.00385 Cu100 = 0.00421 Cu100 = 0.00427 Cu1000 = 0.00421
Sampling Rate	10 samples/sec
Bandwidth	15.7 Hz
Accuracy	±0.1%
Zero Drift	0.5 $\mu\text{V}/^\circ\text{C}$
Span Drift	25 $\mu\text{V}/^\circ\text{C}$
CMR@50/60Hz	150 dB min
NMR@50/60Hz	100 dB min
Isolation	3000 VDC
<b>Modbus RTU</b>	EX-9015H-M
<b>Power</b>	
Requirements	+10 to +30 VDC
Consumption	0.8 W
<b>Temperature Range</b>	
Operating	-25°C to +75°C
Storage	-30°C to +75°C

**Notes:**

1. Warm-UP for 30 minutes is recommended!

## 1.2 Wire connection

### 1.2.1 Block Diagrams

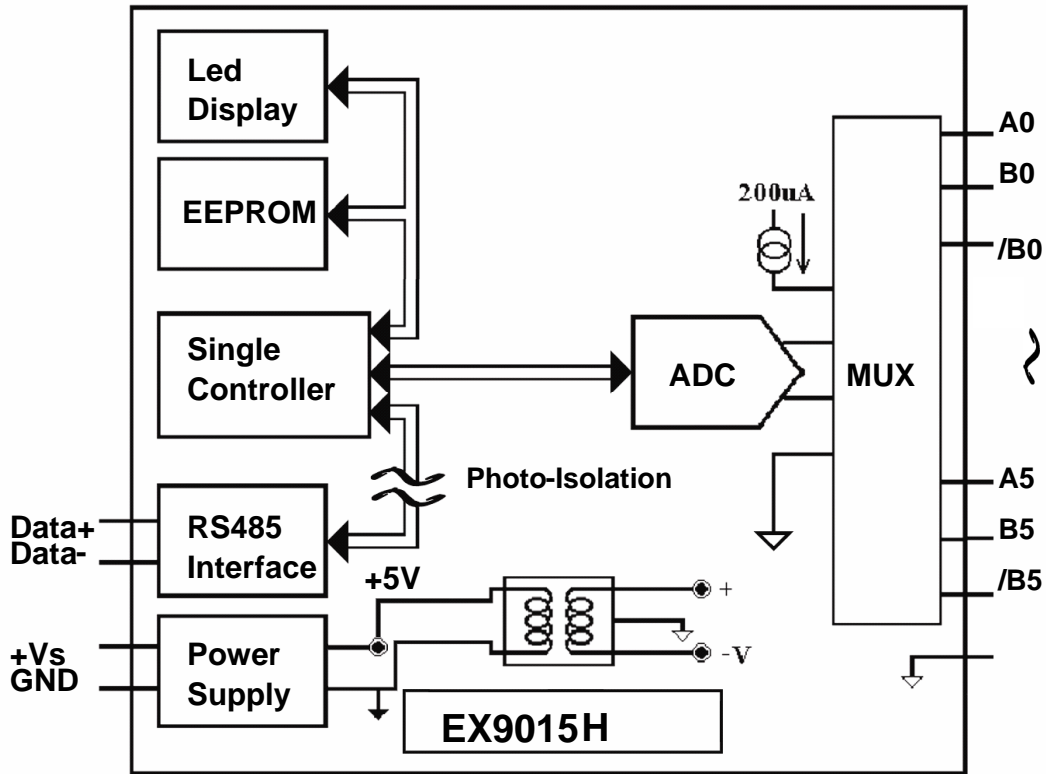

### 1.2.2 Wiring diagram for the EX-9015H/15H-M

2-wire RTD connection

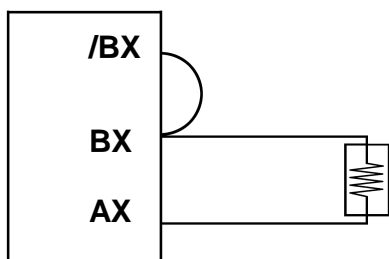

3-wire RTD connection

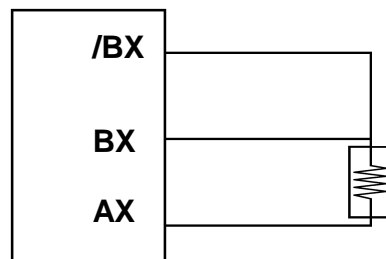

## Pin assignments:

Pin	Name	Description
1	B4	RTD Sense- of channel 4
2	A4	RTD Sense+ of channel 4
3	/B5	Execution current of channel 5
4	B5	RTD Sense- of channel 5
5	A5	RTD Sense+ of channel 5
6	DATA+	Signal, positive
7	DATA-	Signal, negative
8	+VS	+10V ~ +30VDC
9	GND	Ground
10	DATA+	Signal, positive
11	DATA-	Signal, negative
12	+VS	+10V ~ +30VDC
13	GND	Ground
14	A0	RTD Sense+ of channel 0
15	B0	RTD Sense- of channel 0
16	/B0	Execution current of channel 0
17	A1	RTD Sense+ of channel 1
18	B1	RTD Sense- of channel 1
19	/B1	Execution current of channel 1
20	A2	RTD Sense+ of channel 2
21	B2	RTD Sense- of channel 2
22	/B2	Execution current of channel 2
23	A3	RTD Sense+ of channel 3
24	B3	RTD Sense- of channel 3
25	/B3	Execution current of channel 3
26	/B4	Execution current of channel 4

### **1.2.3 Wiring Recommendations**

1. For the EX-9015H, it is recommended to use shielded wire and connect the shielding to the Execution current of channel(/B0;/B1;/B2;/B3;/B4;/B5).
2. For RS-485, use insulated and twisted pair 24 AWG wire, e.g. Belden 9841.
3. Use 26-12 AWG wire for signal connections.

## 1.3 Default Settings

Default settings for the EX-9015H modules are as follows:

- . Module Address: 01
- . RTD Type: Type 20, Pt100, -100°C to 100°C
- . Baud Rate: 9600 bps
- . Checksum disabled
- . Engineering unit format
- . Filter set at 60Hz rejection

Default settings for the EX-9015H-M modules are as follows:

- . Protocol: Modbus RTU
- . Module Address: 01
- . RTD Type: Type 20, Pt100, -100°C to 100°C
- . Baud Rate: 9600 bps
- . Checksum(CRC in modbus): enable
- . Filter set at 60Hz rejection

## 1.4 INIT\* Mode Operation

Each EX9000 module has a build-in EEPROM to store configuration information such as address, type, baudrate and other information. Sometimes, user may forget the configuration of the module. Therefore, the EX9000 have a special mode named "INIT\* mode" to help user to resolve the problem. The "INIT\* mode" is setting as Address=00, Budrate=9600bps, no Checksum .

Originally, the INIT\* mode is accessed by connecting the INIT\* terminal to the GND terminal. New EX9000 modules have the INIT\* switch located on the rear side of the module to allow easier access to the INIT\* mode. For these modules, INIT\* mode is accessed by sliding the INIT\* switch to the Init position as shown below.

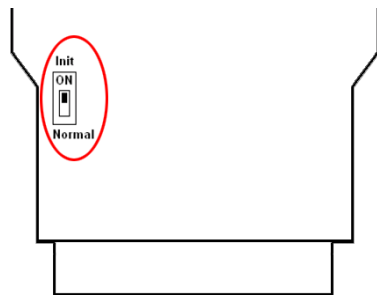

To enable INIT\* mode, please following these steps:

Step1. Power off the module

Step2. Connect the INIT\* pin with the GND pin.

(or sliding the INIT\* switch to the Init\* ON position)

Step3. Power on

Step4. Send command \$002 (cr) in 9600bps to read the Configuration stored in the module's EEPROM.

There are commands that require the module to be in INIT\* mode. They are:

1. %AANNTTCCFF when changing the Baud Rate and checksum settings. See Section 2.1 for details.
2. \$AAPN, See Section 2.18 for details.



## 1.5 Module Status for DIO, AIO

**Power On Reset** or **Module Watchdog Reset** will let all output goto **Power On Value**. And the module may accept the host's command to change the output value.

**Host Watchdog Timeout** will let all output goto **Safe Value**. The module's status(read by command~AA0) will be 04, and the output command will be ignored.

## 1.6 Dual Watchdog Operation for DIO, AIO

**Dual Watchdog=Module Watchdog + Host Watchdog**

The Module Watchdog is a hardware reset circuit to monitor the module's operating status. While working in harsh or noisy environment, the module may be down by the external signal. The circuit may let the module to work continues and never halt.

The Host Watchdog is a software function to monitor the host's operating status. Its purpose is to prevent the network from communication problem or host halt. When the timeout interval expired, the module will turn all outputs to predefined Safe Value. This can prevent the controlled target from unexpected situation.

The EX9000 module with Dual Watchdog may let the control system more reliable and stable.

## 1.7 Reset Status

The Reset Status is set while the module power on or reset by module watchdog and is cleared while the command read Reset Status (\$AA5) applied. This is useful for user to check the module's working status. When the Reset Status is set means the module is reset and the output may be changed to the PowerOn Value. When the Reset Status is clear means the module is not rested and the output is not changed.

## 1.8 Calibration (Warning: Please don't calibrate before you really understand.)

### Calibration resistor types used by the EX9015H/15H-M:

Type	Zero Calibration Resistor	Span Calibration Resistor
20	0 Ohms	200 Ohms
2A/2D	0 Ohms	2000 Ohms

Types 21/22/23/24/25/26/27/28/29/2B/2C/2E/2F/80/81/82/83 same as type 20

Set the module of data format to which you wish to calibration first.

Protocol: ASCII mode.

Address: 01

Input type: PT100, Cu50, Cu100, Ni100, Ni120 set to type:20

PT1000 set to type:2A, Cu1000 set to type:2D

Filter: which rejection you wish to calibration

Perform Zero Calibration:

1. Send the command "\$01501" to **CH0 enable, CH1 ~7 disable**.
2. Apply zero voltage to module's **channel 0** (RTD0+ to RTD0- to AGND)
3. Send the command "~01E1" to enable calibration.
4. Send the command "\$011" to perform zero calibration.
5. Send the command "~01E0" to disable calibration.

Perform Span Calibration(PT100, Cu50, Cu100, Ni100, Ni120):

1. Send the command "\$01502" to **CH1 enable, CH0 & 2~7 disable**.
2. Apply the **200ohms** resistor to CH1+ & CH1-, CH1- to AGND.
3. Send the command "~012X072**100000**" to set the span = \***1.00000**
4. Send the command "~012X051" to read the parameter of resistance as follow:

>AAAAAA,BBBBBB,CCCCCC

AAAAAA=Voltage (/1000 :mV)

BBBBBB=Current (fix to 200 uA)

CCCCCC=Resistance of test result (/1000 :Ohm)

For example: >039922,000200,0199610

Voltage=39.922mV, Current=200uA, Resistance=199.61ohms

5. Please refer the resistance 199.61 ohms to change the of span in step 3 as

"~012X072**100195**" to set the span = \***1.00195**

6. Repeat the step 3~5 until to the resistance is same with the resistor(200ohms)

Perform Span Calibration(PT1000, Cu1000):

1. Send the command "\$01504" to **CH2 enable, CH0~1 & 3~7 disable.**

2. Apply the **2000ohms** resistor to CH2+ & CH2-, CH2- to AGND.

3. Send the command "~012X070**100000**" to set the span = \***1.00000**

4. Send the command "~012X052" to read the parameter of resistance as follow:

>AAAAAA,BBBBBB,CCCCCC

AAAAAA=Voltage (/1000 :mV)

BBBBBB=Current (fix to 200 uA)

CCCCCC=Resistance of test result (/1000 :Ohm)

For example: >397083,00200,1985415

Voltage=397.083mV, Current=200uA, Resistance=1985.415ohms

5. Please refer the resistance 1985.415ohms to change the of span in step 3 as

"~012X072**100734**" to set the span = \***1.00734**

6. Repeat the step 3~5 until to the resistance is same with the resistor(2000ohms)

## 1.9 Configuration Tables

### Baud Rate Setting (CC)

Code	03	04	05	06	07	08	09	0A
Baud rate	1200	2400	4800	9600	19200	38400	57600	115200

### RTD Type Setting (TT)

Type Code	Temperature Sensor Type	Temperature Range °C
20	Platinum 100, $\alpha= 0.00385$	-100 ~ 100
21	Platinum 100, $\alpha= 0.00385$	0 ~ 100
22	Platinum 100, $\alpha= 0.00385$	0 ~ 200
23	Platinum 100, $\alpha= 0.00385$	0 ~ 600
24	Platinum 100, $\alpha= 0.003916$	-100 ~ 100
25	Platinum 100, $\alpha= 0.003916$	0 ~ 100
26	Platinum 100, $\alpha= 0.003916$	0 ~ 200
27	Platinum 100, $\alpha= 0.003916$	0 ~ 600
28	Nickel 120	-80 ~ 100
29	Nickel 120	0 ~ 100
2A	Platinum 1000, $\alpha= 0.00385$	-200 ~ 600
2B	Cu 100 @ 0°C, $\alpha= 0.00421$	-20 ~ 150
2C	Cu 100 @ 25°C, $\alpha= 0.00427$	0 ~ 200
2D	Cu 1000 @ 0°C, $\alpha= 0.00421$	-20 ~ 150
2E	Platinum 100, $\alpha= 0.00385$	-200 ~ 200
2F	Platinum 100, $\alpha= 0.003916$	-200 ~ 200
80	Platinum 100, $\alpha= 0.00385$	-200 ~ 600
81	Platinum 100, $\alpha= 0.003916$	-200 ~ 600
82	Cu 50 @ 0°C	-50 ~ 150
83	Nickel 100	-60 ~ 180

### Data Format Setting (FF)

7	6	5	4	3	2	1	0
FS	CS	reserved				DF	

Key	Description
DF	Data format 00: Engineering unit 01: % of FSR (full scale range) 10: 2's complement hexadecimal 11: Ohms
CS	Checksum( <b>CRC in Modbus</b> ) setting 0: Disabled 1: Enabled
FS	Filter setting 0: 60Hz rejection 1: 50Hz rejection

**Note:** The reserved bits should be zero.

.

## RTD Type and Data Format Table

Type Code	RTD Type	Data Format	+F.S.	-F.S.
20	Platinum 100 = 0.00385 -100 ~ 100°C	Engineering unit	+100.00	-100.00
		% of FSR	+100.00	-100.00
		2's comp HEX	7FFF	8000
		Ohms	+138.50	+060.60
21	Platinum 100 = 0.00385 0 ~ 100°C	Engineering unit	+100.00	+000.00
		% of FSR	+100.00	+100.00
		2's comp HEX	7FFF	0000
		Ohms	+138.50	+100.00
22	Platinum 100 = 0.00385 0 ~ 200°C	Engineering unit	+200.00	+000.00
		% of FSR	+100.00	+000.00
		2's comp HEX	7FFF	0000
		Ohms	+175.84	+100.00
23	Platinum 100 = 0.00385 0 ~ 600°C	Engineering unit	+600.00	+000.00
		% of FSR	+100.00	+000.00
		2's comp HEX	7FFF	0000
		Ohms	+313.59	+100.00
24	Platinum 100 = 0.003916 -100 ~ 100°C	Engineering unit	+100.00	-1000.00
		% of FSR	+100.00	-100.00
		2's comp HEX	7FFF	8000
		Ohms	+139.16	+060.60
25	Platinum 100 = 0.003916 0 ~ 100°C	Engineering unit	+100.00	+000.00
		% of FSR	+100.00	+000.00
		2's comp HEX	7FFF	0000
		Ohms	+139.16	+100.00
26	Platinum 100 = 0.003916 0 ~ 200°C	Engineering unit	+200.00	+000.00
		% of FSR	+100.00	+000.00
		2's comp HEX	7FFF	0000
		Ohms	+177.14	+100.00
27	Platinum 100 = 0.003916 0 ~ 600°C	Engineering unit	+600.00	+000.00
		% of FSR	+100.00	+000.00
		2's comp HEX	7FFF	0000
		Ohms	+317.28	+100.00
28	Nickel 120 -80 ~ 100°C	Engineering unit	+100.00	-080.00
		% of FSR	+100.00	-080.00
		2's comp HEX	7FFF	999A
		Ohms	+200.64	+066.60
29	Nickel 120 0 ~ 100°C	Engineering unit	+100.00	+000.00
		% of FSR	+100.00	+000.00
		2's comp HEX	7FFF	0000
		Ohms	+200.64	+120.60

Type Code	RTD Type	Data Format	+F.S.	-F.S.
2A	Platinum 1000 = 0.00385 -200 ~ 600°C	Engineering unit	+600.00	-200.00
		% of FSR	+100.00	-033.33
		2's comp HEX	7FFF	D556
		Ohms	+3137.1	+0185.2
2B	Cu 100 = 0.00421 -20 ~ 150°C	Engineering unit	+150.00	-020.00
		% of FSR	+100.00	-013.33
		2's comp HEX	7FFF	EEEE
		Ohms	+163.17	+091.56
2C	Cu 100 = 0.00427 0 ~ 200°C	Engineering unit	+200.00	+000.00
		% of FSR	+100.00	+000.00
		2's comp HEX	7FFF	0000
		Ohms	+167.75	+090.34
2D	Cu 100 = 0.00421 -20 ~ 150°C	Engineering unit	+150.00	-020.00
		% of FSR	+100.00	-013.33
		2's comp HEX	7FFF	EEEE
		Ohms	+1631.7	+0915.6
2E	Platinum 100 = 0.00385 -200 ~ 200°C	Engineering unit	+200.00	-200.00
		% of FSR	+100.00	-100.00
		2's comp HEX	7FFF	8000
		Ohms	+175.84	+018.49
2F	Platinum 100 = 0.003916 -200 ~ 200°C	Engineering unit	+200.00	-200.00
		% of FSR	+100.00	-100.00
		2's comp HEX	7FFF	8000
		Ohms	+177.14	+017.14
80	Platinum 100 = 0.00385 -200 ~ 600°C	Engineering unit	+600.00	-200.00
		% of FSR	+100.00	-033.33
		2's comp HEX	7FFF	D556
		Ohms	+313.59	+018.49
81	Platinum 100 = 0.003916 -200 ~ 600°C	Engineering unit	+600.00	-200.00
		% of FSR	+100.00	-033.33
		2's comp HEX	7FFF	D556
		Ohms	+317.28	+017.14
82	Cu 50 -50 ~ 150°C	Engineering unit	+150.00	-050.00
		% of FSR	+100.00	-033.33
		2's comp HEX	7FFF	D556
		Ohms	+082.13	+039.24
83	Nickel 100 -60 ~ 180°C	Engineering unit	+180.00	-060.00
		% of FSR	+100.00	-033.33
		2's comp HEX	7FFF	D556
		Ohms	+223.10	+069.50

## **RTD Over Range/Under Range Reading**

	Over Range	Under Range
Engineering Unit	+9999.9	-9999.9
% of FSR	+999.99	-999.99
2's Complement HEX	7FFF	8000

## **RTD Over Range/Under Range Reading for the EX-9015H-M with Modbus RTU Protocol**

Over Range	Under Range
7FFFh	8000h



## 2.0 Command Sets

### 2.1 %AANNTTCCFF

**Description: Set Module Configuration.**

**Syntax: %AANNTTCCFF[CHK](cr)**

**%** a delimiter character

**AA** address of setting/response module(00 to FF)

**NN** new address for setting/response module(00 to FF)

**TT** Always be 20

**CC** new baudrate for setting module.

**FF** new data format for setting module.

IF the configuration with new baudrate or new checksum setting, before using this command, the rear slide switch must be in the ON(INIT\*) position. The new setting is saved in the EEPROM and will be effective after the next power-on reset.

**Response: Valid Command: !AA**

**Invalid Command: ?AA**

**Example:**

**Command :%0102200600**

**Receive:!02**

**Set module address 01 to 02, return Success.**

## **2.2 #\*\***

**Description: Synchronized Sampling**

**Syntax: #\*\*[CHK](cr)**

**#** delimiter character

**\*\*** synchronized sampling command

**Response: No response**

**Example:**

**Command: #\*\***

**No response**

**Send synchronized sampling command to all modules.**

**Command: \$014**

**Receive:**

**>011+010.123+030.931+022.153+025.028-031.395+022.421**

**Read synchronized data from address 01, return S=1, first read and data is**

**+010.123+030.931+022.153+025.028-031.395+022.421**

**Command: \$014**

**Receive:**

**>010+010.123+030.931+022.153+025.028-031.395+022.421**

**Read synchronized data from address 01, return S=0, have readed and data is**

**+010.123+030.931+022.153+025.028-031.395+022.421**

## **2.3 #AA**

**Description: Read Analog Input**

**Syntax: #AA[CHK](cr)**

**#** delimiter character

**AA** address of reading/response module(00 to FF)

**Response: Valid Command: >(Data)**

**(Data) analog input value for its format while use #AA command to EX9015H, the data is the combination for each channel respectively.**

**Example :**

**Command: #04**

**Receive: >+051.23+041.53+072.34-023.56+100.00-051.33**

**Read address 04 for getting data of all 6 channels.**

## 2.4 #AAN

**Description :** Read Analog Input from channel N

**Syntax :** #AAN[CHK](cr)

**#** delimiter character

**AA** address of reading/response module(00 to FF)

**N** channel to read, from 0 to 5

**Response: Valid Command:** >(Data)

**Invalid Command:** ?AA

**(Data)** analog input value for its format

**Example :**

**Command :** #032

**Receive :** >+025.13

**Read address 03 channel 2, get data successfully.**

**Command :** #029

**Receive :** ?02

**Read address 02 channel 9, return error channel number.**

## 2.5 \$AA0Ci

**Description:** Perform zero calibration on the specified channel.

**Syntax:** \$AA0Ci[CHK](cr)

**\$** delimiter character

**AA** address of setting/response module (00 to FF)

**0** command for the zero calibration

**Ci** specifies the channel to be calibrated (i=0~5)

**Response:** Valid Command: !AA

Invalid Command: ?AA

**Example:**

Command : \$010C0                      Receive : !01

Perform address 01 zero calibration on channel 0, return success.

Command : \$020C2                      Receive : ?02

Perform address 02 zero calibration on channel 2, return not enable calibration before perform calibration command.

**Note:** This command must be sent before the “span calibration” command, \$AA1Ci, is used.

## 2.6 \$AA1Ci

**Description:** Perform span calibration on the specified channel.

**Syntax:** \$AA1Ci[CHK](cr)

**\$** delimiter character

**AA** address of setting/response module (00 to FF)

**1** command for performing span calibration

**Ci** specifies the channel to be calibrated (i=0~5)

**Response:** Valid Command: !AA

Invalid Command: ?AA

**Example:**

**Command:** \$011C0 **Receive:** !01

Perform address 01 span calibration on channel 0, return success.

**Command:** \$021C2 **Receive:** ?02

Perform address 02 span calibration on channel 2, return not enable calibration before perform calibration command.

## 2.7 \$AA2

**Description:** Read configuration.

**Syntax:** \$AA2[CHK](cr)

**\$** delimiter character

**AA** address of reading/response module(00 to FF)

**2** command for read configuration

**Response:** Valid Command: !AATTCCFF

Invalid Command: ?AA

**TT** type code of the module

**CC** baud Rate code of the module

**FF** data format, checksum settings and filter settings of the module

**Example:**

**Command:** \$012

**Receive:** !01200600

**Read the configuration of module 01.**

**Note:** check configuration Tables

## 2.8 \$AA4

**Description:** Reads the synchronized data

**Syntax:** \$AA4[CHK](cr)

**\$** delimiter character

**AA** address of reading/response module(00 to FF)

**4** command to read the synchronized data

**Response:** Valid Command: >AAS(Data)

Invalid Command: ?AA

**S** status of synchronized data, 1=first read, 0=been readed

(Data) synchronized value

**Example:**

**Command:** \$014

**Receive:** ?01

Read address 01 synchronized data, return no data available.

**Command:** #\*\*

**Receive:** no response

Send synchronized sampling to all modules.

**Command:** \$014

**Receive:**>011+051.23+041.53+072.21+041.21+011.13+032.34

Read address 01 synchronized data, return S=1, first read, and synchronized data

+051.23+041.53+072.21+041.21+011.13+032.34



## **2.9 \$AA5**

**Description: Read Reset Status**

**Syntax:\$AA5[CHK](cr)**

**\$** delimiter character

**AA** address of reading/response module(00 to FF)

**5** command for read reset status

**Response: Valid Command: !AAS**

**Invalid Command: ?AA**

**S** reset status, 1=the module is been reset, 0=the module is not been rested

**Example:**

**Command: \$ 015**

**Receive: !011**

**Read address 01 reset status, return module is been reset**

**Command: \$ 015**

**Receive: !010**

**Read address 01 reset status, return no reset occurred.**

## 2.10 \$AA5VV

**Description: Set Channel Enable**

**Syntax:\$AA5VV[CHK](cr)**

**\$** delimiter character

**AA** address of setting/response module (00 to FF)

**5** command for set channel enable

**VV** channel enable/disable, 00 is all disabled and FF is all enabled.

**Response: Valid Command: !AA**

**Invalid Command: ?AA**

**Example:**

**Command :\$0152A**

**Receive : !01**

**Set address 01 to enable channel 1,3,5 and disable channel 0,2,5 return success.**

**Command : \$016**

**Receive : !012A**

**Read address 01 channel status, return channel 1,3,5 are enabled and channel 0,2,4 are disabled.**

## 2.11 \$AA6

**Description: Read Channel Status**

**Syntax: \$AA6[CHK](cr)**

**\$** delimiter character

**AA** address of reading/response module (00 to FF)

**6** command for read channel status

**Response: Valid Command: !AAVV**

**Invalid Command: ?AA**

**VV** channel enable/disable, 00 is all disabled and FF is all enabled.

**Example:**

**Command :\$0152A                      Receive : !01**

**Set address 01 to enable channel 1,3,5 and disable channel 0,2,4 return success.**

**Command : \$016    Receive : !012A**

**Reads Read address 01 channel status, return channel 1,3,5 are enabled and channel 0,2,4 are disabled.**

## 2.12 \$AA7CiRrr

**Description:** Sets the type code of a channel.

**Syntax:** \$AA7CiRrr[CHK](cr)

**\$** delimiter character

**AA** address of setting/response module(00 to FF)

**7** set the channel range code

**Ci** i specifies the input channel to be set (i=0~5)

**Rrr** rr represents the type code of the channel to be set.

**Response: Valid command:** !AA

**Invalid command:** ?AA

### Example:

**Command:** \$017C0R20

**Receive:** !01

Sets the type code for channel 0 of module 01 to be 20 (PT100, -100 ~ +100°C) and the module returns a valid response.

**Command:** \$027C5R28

**Receive:** !02

Sets the type code for channel 5 of module 02 to be 28 (Ni120, -80 ~ +100°C) and the module returns a valid response.

**Command:** \$037C1R40

**Receive:** ?03

Sets the type code for channel 1 of module 03 to be 40. The module returns an invalid response because the type code is invalid.

## 2.13 \$AA8Ci

**Description:** Reads the type code information of a channel.

**Syntax:** \$AA8Ci[CHK](cr)

**\$** delimiter character

**AA** address of reading/response module(00 to FF)

**8** read the type code of a channel

**Ci** specifies which channel to be access for the type code  
(i=0~5)

**Response:** Valid command: !AACiRrr

Invalid command: ?AA

**Ci** specifies which channel to be access for the type code  
(i=0~5)

**Rrr** rr represents the type code of the channel to be read

**Example:**

**Command:** \$018C0

**Receive:** !01C0R20

Reads the type(input range) of channel 0 of module 01 to be  
20 (PT100, -100 ~ +100°C).

## 2.14 \$AAB

**Description:** Diagnoses the analog inputs for over-range, under-range, and wire opening conditions.

**Syntax:** \$AAB[CHK](cr)

**\$** delimiter character

**AA** address of reading/response module (00 to FF)

**B** diagnose the analog inputs

**Response:** Valid command: !AANN

Invalid command: ?AA

**NN** represents the diagnostic results of all the analog input channels (00 to FF) where bit 0 relat to channel 0, bit 1 relat to channel 1, etc. When the bit is 1 and the channel is enabled and it is in either overrange, under-range or wire opening condition. If the bit is 0 and the channel is disabled or normal.

**Example:**

**Command:** \$01B

**Receive:** !0101

Diagnoses the analog inputs of module 01. The module returns a valid response that channel 0 is in either over-range, under-range or wire opening condition.

## 2.15 \$AAF

**Description: Read Firmware Version**

**Syntax:\$AAF[CHK](cr)**

**\$** delimiter character

**AA** address of reading/response module(00 to FF)

**F** command for read firmware version

**Response: Valid command: !AA(Data)**

**Invalid command: ?AA**

**(Data) Firmware version of module**

**Example:**

**Command : \$01F** **Receive : !01P1.1**

**Read address 01 firmware version, return version P1.1.**

**Command : \$01F** **Receive : !01M1.1**

**Read address 01 firmware version, return version M1.1**

## **2.16 \$AAM**

**Description:Read Module Name**

**Syntax:\$AAM[CHK](cr)**

**\$** delimiter character

**AA** address of reading/response module(00 to FF)

**M** command for read module name

**Response: Valid command: !AA(Data)**

**Invalid command: ?AA**

**(Data) Name of module**

**Example:**

**Command : \$01M**

**Receive : !019015H**

**Read address 01 module name, return name 9015H.**



## **2.17 \$AAP (For EX9015H-M)**

**Description:**Read protocol information of Module

**Syntax:**\$AAP[CHK](cr)

**\$** delimiter character

**AA** address of reading/response module(00 to FF)

**P** command for read protocol information of module

**Response:** Valid command: !AAS

Invalid command: ?AA

**S** The protocol supported by the module

10: the protocol set in EEPROM is Normal mode

11: the protocol set in EEPROM is Modbus RTU mode

**Example:**

**Command:** \$01P

**Response:** !0110

Reads the communication protocol of module 01 and returns a response of 10 meaning the protocol that will be used at the next power on reset is normal mode.

**Command:** \$01P1

**Response:** !01

Sets the communication protocol of module 01 to Modbus RTU and returns a valid response. And the next power on reset is in Modbus RTU mode.

## **2.18 \$AAPN (For EX9015H-M)**

**Description:**Set the protocol information of Module

**Syntax:****\$AAPN[CHK](cr)**

**\$** delimiter character

**AA** address of reading/response module(00 to FF)

**P** command for read protocol information of module

**N** The protocol supported by the module

**0:** the protocol set in EEPROM is Normal mode

**1:** the protocol set in EEPROM is Modbus RTU mode

**Response:** Valid command: **!AA**

Invalid command: **?AA**

**Example:**

**Command:** **\$01P1**

**Response:** **!01**

**Sets the communication protocol of module 01 to Modbus RTU and returns a valid response. And the next power on reset is in Modbus RTU mode.**

## **2.19 \$AAS0**

**Description:** Perform an internal calibration

**Syntax:** \$AAS0[CHK](cr)

**\$** delimiter character

**AA** address of setting/response module(00 to FF)

**S0** perform the internal calibration

**Response:** Valid command:           !AA

                  Invalid command:       ?AA

**Example:**

**Command:** \$01S0

**Receive:** !01

Perform an internal calibration on module 01 and returns a valid response.

## 2.20 ~AAEV

**Description:** Enable/Disable Calibration

**Syntax:**~AAEV[CHK](CR)

**~** delimiter character

**AA** address of setting/response module (00 to FF)

**E** command for enable/disable calibration

**V** 1=Enable/0=Disable calibration

**Response:** Valid Command: !AA

Invalid Command: ?AA

### Example:

**Command :** \$010 **Receive:** ?01

Perform address 01 span calibration, return the command is invalid before enable calibration.

**Command :** ~01E1 **Receive:** !01

Set address 01 to enable calibration, return success.

**Command:** \$010 **Receive:** !01

Perform address 01 span calibration, return success.

**Warning:** Pls don't calibrate before you really understand.

## **2.21 ~AAO(Data)**

**Description:**Set Module Name

**Syntax:**~AAO(Data)[CHK](cr)

**~** delimiter character

**AA** address of setting/response module(00 to FF)

**O** command for set module name

**(Data)** new name for module, max 6 characters

**Response:** Valid command:           **!AA**

                  Invalid command:       **?AA**

**Example:**

**Command:**~01O9015                           **Receive :!**01

**Set address 01 module name 9015, return success.**

**Command :** \$01M                               **Receive : !**019015H

**Read address 01 module name, return name 9015H.**

## **2.22 ~\*\***

**Description:** Host OK.

Host send this command to all modules for send the information "Host OK"

**Syntax:**~\*\*[CHK](cr)

~ delimiter character

\*\* command for all modules

**Response:** No response.

**Example:**

**Command:** ~\*\*            **No response**

## 2.23 ~AA0

**Description: Read Module Host Watchdog Status.**

**Syntax:~AA0[CHK](cr)**

**~** delimiter character

**AA** address of reading/response module(00 to FF)

**0** command for read module status

**Response: Valid command: !AASS**

**Invalid command: ?AA**

**SS** module status, 00= host watchdog is disabled & host watchdog timeout status is clear, 80= host watchdog is enabled & host watchdog timeout status is clear. 84= host watchdog is enabled & host watchdog timeout status is set . The status will store into EEPROM and only may reset by the command~AA1.

SS	Host watchdog	Host watchdog timeout status
00	Disable	Clear
80	Enable	Clear
84	Enable	Set

## **2.24 ~AA1**

**Description: Reset Module Host Watchdog Status.**

**Syntax: ~AA1[CHK](cr)**

**~** delimiter character

**AA** address of setting/response module(00 to FF)

**1** command for reset module status

**Response: Valid command: !AA**

**Invalid command: ?AA**



## **2.25 ~AA2**

**Description: Read Host Watchdog Timeout Value**

**Syntax:~AA2[CHK](cr)**

**~** delimiter character

**AA** address of reading/response module(00 to FF)

**2** command for read host watchdog timeout value

**Response: Valid command :** !AAEVV

**Invalid command:** ?AA

**E** host watchdog enable status, 1=Enable, 0=Disable

**VV** timeout value in HEX format, each count is 0.1 second

**01=0.1 second and FF=25.5 seconds**



**Command : ~011**

**Receive : !01**

**Reset address 01 host watchdog timeout status, return success And the LED of this module stop flash.**

**Command : ~010**

**Receive : !0100**

**Read address 01 module status, return host watchdog timeout status is clear.**

## EX9015H-M Quick Start

1. The default setting is MODBUS mode after Power On.

2. Sliding the INIT\* switch to the Init(ON) position of rear side then Power On will enter INIT\* mode (use ASCII command).

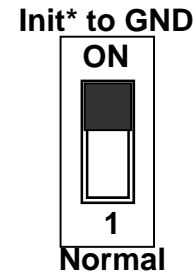

3. On ASCII command mode, user can set other setting like Address, Baudrate, ...by use ASCII command or EX-9000 utility (Please check the EX-9000 user manual).

**Note:** If your application need with CRC check in modbus mode, please set the module to checksum(CRC) enable.

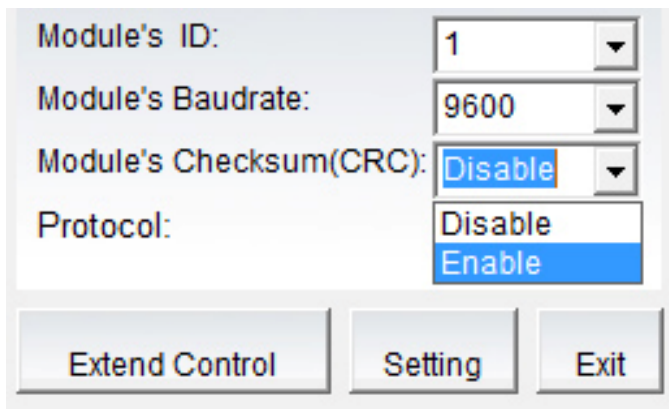

4. After change the setting finish, Sliding the INIT\* switch to the Normal(1) position of rear side, the new setting will be effective after the next power-on reset.

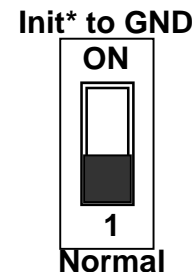

**This function code is used to read from 1 to 6 continuous analog input channels.**

**Request**

00	Address	1Byte	1 to 247
01	Function code	1Byete	0x04
02-03	Starting channel	2 Bytes	0 to 7 for reading analog inputs
04-05	Number of input Channels(N)	2Bytes	1 to 8;(Starting channel+N)<=8 for reading analog inputs

**Response**

00	Address	1Byte	1 to 247
01	Function code	1Byete	0x04
02	Byte count	1 Byte	2 x N
03~	Data of input channels	2 x N Bytes	

**Error Response**

00	Address	1Byte	1 to 247
01	Function code	1Byete	0x84
	Exception code	1 Byte	02:starting channel out of range 03:( starting channel+number of input channels) out of range, incorrect number of bytes received

## 01(0x01) Read WDT timeout status

### Request

00	Address	1 Byte	1-247
01	Function code	1 Byte	0x01
02~03	Starting channel	2 Bytes	0x010D
04~05	Read WDT timeout status	2 Bytes	0x0001

### Response

00	Address	1 Byte	1-247
01	Function code	1 Byte	0x01
02	Byte count	1 Byte	1
03	Read WDT timeout status	1 Byte	0x00 The WDT timeout status is clear 0x01 The WDT timeout status is enable

### Error Response

00	Address	1 Byte	1-247
01	Function code	1 Byte	0x81
02	Exception code	1 Byte	Refer to the Modbus standard for more details.

## 03(0x03) Read WDT timeout Value

### Request

00	Address	1 Byte	1-247
01	Function code	1 Byte	0x03
02~03	Starting channel	2 Bytes	0x01E8
04~05	Read WDT timeout value	2 Bytes	0x0001

### Response

00	Address	1 Byte	1-247
01	Function code	1 Byte	0x03
02	Byte count	1 Byte	2
03~	Read WDT timeout value	1 Byte	0x0000~0x00FF WDT timeout value, 0~255, in 0.1 second

### Error Response

00	Address	1 Byte	1-247
01	Function code	1 Byte	0x83
02	Exception code	1 Byte	Refer to the Modbus standard for more details.

### **03(0x03) Send Host OK**

#### **Request**

00	Address	1 Byte	1-247
01	Function code	1 Byte	0x03
02~03	Starting channel	2 Bytes	0x3038
04~05	Send Host OK	2 Bytes	0x0000

#### **No Response**

### **04(0x04) Send Host OK**

#### **Request**

00	Address	1 Byte	1-247
01	Function code	1 Byte	0x04
02~03	Starting channel	2 Bytes	0x3038
04~05	Send Host OK	2 Bytes	0x0000

#### **No Response**



## 05(0x05) Set WDT timeout /Clear WDT timeout status

### Request

00	Address	1 Byte	1-247
01	Function code	1 Byte	0x05
02~03	WDT timeout	2 Bytes	0x0104 Set WDT timeout enable/disable 0x010D Clear WDT timeout status
04~05	WDT timeout	2 Bytes	0xFF00 for WDT timeout enable 0x0000 for WDT timeout disable 0xFF00 for Clear WDT timeout status

### Response

00	Address	1 Byte	1-247
01	Function code	1 Byte	0x05
02~03	WDT timeout	2 Bytes	The value is the same as byte 02 and 03 of the Request
04~05	WDT timeout	2 Bytes	The value is the same as byte 04 and 05 of the Request

### Error Response

00	Address	1 Byte	1-247
01	Function code	1 Byte	0x85
02	Exception code	1 Byte	Refer to the Modbus standard for more details.

## 06(0x06) Set WDT timeout Value

### Request

00	Address	1 Byte	1-247
01	Function code	1 Byte	0x06
02~03	Starting channel	2 Bytes	0x01E8
04~05	WDT timeout value	2 Bytes	0x0000~0x00FF WDT timeout value, 0~255, in 0.1 second

### Response

00	Address	1 Byte	1-247
01	Function code	1 Byte	0x06
02~03	WDT timeout value	2 Bytes	The value is the same as byte 02 and 03 of the Request
04~05	WDT timeout value	2 Bytes	The value is the same as byte 04 and 05 of the Request

### Error Response

00	Address	1 Byte	1-247
01	Function code	1 Byte	0x86
02	Exception code	1 Byte	Refer to the Modbus standard for more details.

## 9015H-M Modbus mapping:

<b>General</b>			
Protocol of Module	00257	R/W	0x00(0x0000): ASCII command, 0x01(0xFF00): ModbusRTU new protocol is effective after module reboot.
Module name	40483~40484	R	0x0090 0x1500 example for 9015H
Module address	40485	R/W	0x0000~0x00F7(1~247) new address is effective after module reboot.
Module baudrate	40486	R/W	0x0003~0x000A (the table please check the user manual) new baudrate is effective after module reboot.
<b>AI function</b>			
Analog input Value	40001~40006	R	0x0000~0x7FFF
Input type Code	40257~40262	R/W	0x0000~0x0015 (the table please check the user manual)
Modbus data format	40269	R/W	0x0000: engineer format, 0x0001: Hex 2's comp
Channel offset value	40291~40298	R/W	0xFF80(-128)~0x007F(+127) Hex 2's comp to dec then / 10
Module name	40483~40484	R	0x0090 0x1500
Channel enable	40221	R/W	0x0000~0x003F (0:off, 1:on)
Over/under range status	00129~00134	R	0x00: the channel is disable or normal 0x01: the channel is over/under range
<b>WDT</b>			
Informs module host is OK	312345 412345	R	No response
WDT timeout value	40489	R/W	0x0000~0x00FF, 0~255 in 0.1 second
WDT enable/disable	00261	R/W	0x00(0x0000):disable, 0x01(0xFF00):enable
WDT timeout status	00270	R/W	0x00: not timeout, 0x01:WDT timeout (write 0xFF00 to clear WDT timeout status)
<b>Sub-function (0x46)</b>			
Module name	AA 46 00	R	01 46 00 <b>00 90 15 00</b>
Set module's address	AA 46 04 NN 00 00 00	W	NN: new address, 01~F7(1~247) new address is effective after module reboot.

## MODBUS Hex 2's complement Data Format Table

Type Code	RTD Type	Min.	Max.	Formula
20	Platinum 100 = 0.00385 (-100 ~ 100°C)	8001	7FFF	Temp.=(Modbus data*100) /32767 °C
21	Platinum 100 = 0.00385 (0 ~ 100°C)	0000	7FFF	Temp.=(Modbus data*100) /32767 °C
22	Platinum 100 = 0.00385 (0 ~ 200°C)	0000	7FFF	Temp.=(Modbus data*200) /32767 °C
23	Platinum 100 = 0.00385 (0 ~ 600°C)	0000	7FFF	Temp.=(Modbus data*600) /32767 °C
24	Platinum 100 = 0.003916 (-100 ~ 100°C)	8001	7FFF	Temp.=(Modbus data*100) /32767 °C
25	Platinum 100 = 0.003916 (0 ~ 100°C)	0000	7FFF	Temp.=(Modbus data*100) /32767 °C
26	Platinum 100 = 0.003916 (0 ~ 200°C)	0000	7FFF	Temp.=(Modbus data*200) /32767 °C
27	Platinum 100 = 0.003916 (0 ~ 600°C)	0000	7FFF	Temp.=(Modbus data*600) /32767 °C
28	Nickel 120 (-80 ~ 100°C)	999B	7FFF	Temp.=(Modbus data*100) /32767 °C
29	Nickel 120 (0 ~ 100°C)	0000	7FFF	Temp.=(Modbus data*100) /32767 °C
2A	Platinum 1000 = 0.00385 (-200 ~ 600°C)	D556	7FFF	Temp.=(Modbus data*600) /32767 °C
2B	Cu 100 = 0.00421 (-20 ~ 150°C)	EEF0	7FFF	Temp.=(Modbus data*150) /32767 °C
2C	Cu 100 = 0.00427 (0 ~ 200°C)	0000	7FFF	Temp.=(Modbus data*200) /32767 °C
2D	Cu 1000 = 0.00421 (-20 ~ 150°C)	EEF0	7FFF	Temp.=(Modbus data*150) /32767 °C
2E	Platinum 100 = 0.00385 (-200 ~ 200°C)	8001	7FFF	Temp.=(Modbus data*200) /32767 °C
2F	Platinum 100 = 0.003916 (-200 ~ 200°C)	8001	7FFF	Temp.=(Modbus data*200) /32767 °C
80	Platinum 100 = 0.00385 (-200 ~ 600°C)	D556	7FFF	Temp.=(Modbus data*600) /32767 °C
81	Platinum 100 = 0.003916 (-200 ~ 600°C)	D556	7FFF	Temp.=(Modbus data*600) /32767 °C
82	Cu 50 (-50 ~ 150°C)	D556	7FFF	Temp.=(Modbus data*150) /32767 °C
83	Nickel 100 (-60 ~ 180°C)	D556	7FFF	Temp.=(Modbus data*180) /32767 °C

Example: Assume type of channel 2 is 2E and Modbus data=0x2030(Hex)=8240(Dec)

The temperature of channel 2 is  $(8240*200)/32767=50.294$  °C